

© 2013 Essentra Components. All rights reserved.
 Registered in England, Company No. 547495.
 Registered Office: Essentra plc
 Langford Locks, Kidlington, Oxford, OX5 1HX

Condition of Sale can be found on our website: essentra.com.

Essentra Components does not warrant that the files will be error free and may create new versions ("Upgrades") at any time, which may correct such errors. Essentra Components has no obligation to notify you of such upgrades. Any upgraded file will be published to the website, when it becomes available.

You are not permitted to load any of the files on to a network server for the purposes of distribution to one or more other computer(s) on that network or to effect such distribution. Essentra Components shall not be liable for any loss or damage whatsoever or however caused, arising directly or indirectly from the use of the files.

UNCONTROLLED COPY

STATUS **APPROVED DRAWING**

UNLESS OTHERWISE STATED

ALL DIMENSIONS IN mm

DO NOT SCALE

LINEAR TOLERANCE

THIRD ANGLE PROJECTION

SIZE	(0)	(0.0)	(0.00)
0-10	±0.5	±0.15	±0.10
>10-30	±0.5	±0.20	±0.15
>30-50	±0.5	±0.30	±0.20
>50-100	±0.8	±0.50	±0.25
>100-200	±1.5	±0.80	±0.40
>200-300	±2.0	±1.20	±0.80
>300-500	±3.0	±2.00	±1.00
>500	±5.0	±3.00	±1.50

ANGULAR TOLERANCE ±0.5 DEGREES
UNSPECIFIED RADII 0.25mm
DRAFT ANGLE 0.5 DEGREES
DIMENSIONS IN PARENTHESIS () ARE FOR REFERENCE ONLY

ITEM CODE	20481513	CREATE DATE	20/03/2025
LEGACY CODE	12SWS0922B	MATERIAL	PA66
		COLOUR	BLACK
		FINISH	-

TITLE:
SHOULDER WASHER

DWG. No.	20481513	SCALE	5:1	ISSUE	1
		SHEET	1 of 2		

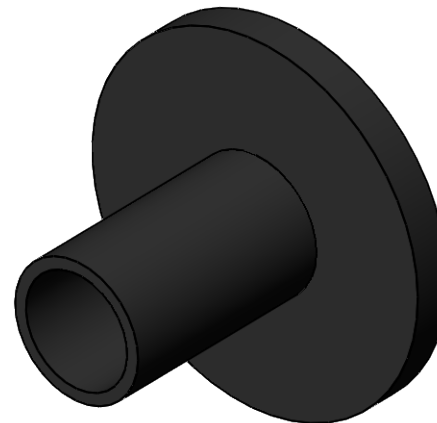
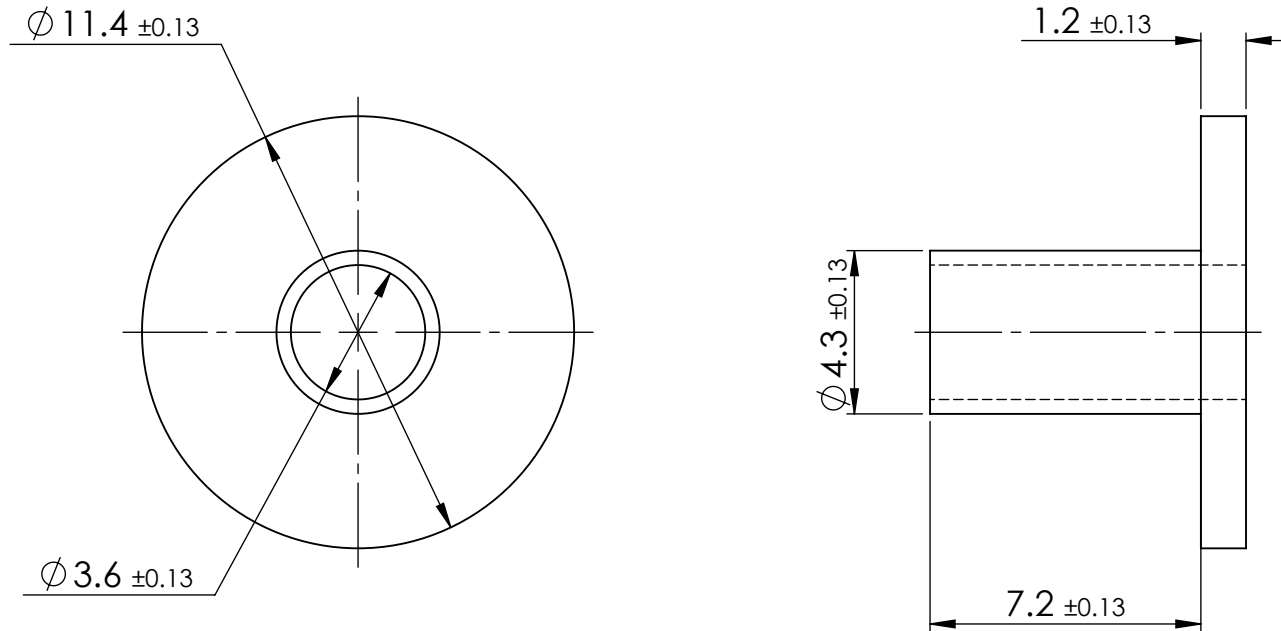

Essentra Components does not warrant that the files will be error free and may create new versions ("Upgrades") at any time, which may correct such errors. Essentra Components has no obligation to notify you of such upgrades. Any upgraded file will be published to the website, when it becomes available.

You are not permitted to load any of the files on to a network server for the purposes of distribution to one or more other computer(s) on that network or to effect such distribution. Essentra Components shall not be liable for any loss or damage whatsoever or however caused, arising directly or indirectly from the use of the files.

UNCONTROLLED COPY

STATUS **APPROVED DRAWING**

UNLESS OTHERWISE STATED

ALL DIMENSIONS IN inches DO NOT SCALE

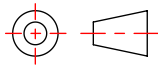
LINEAR TOLERANCE				THIRD ANGLE PROJECTION	
SIZE	(0.00)	(0.000)	(0.0000)		
0 - 0.394	±0.020	±0.006	±0.004		
>0.394 - 1.181	±0.020	±0.008	±0.006		
>1.181 - 1.969	±0.020	±0.012	±0.008		
>1.969 - 3.937	±0.031	±0.020	±0.010		
>3.937 - 7.874	±0.059	±0.031	±0.016		
>7.874 - 11.811	±0.079	±0.047	±0.031		
>11.811 - 19.685	±0.118	±0.079	±0.039		
>19.685	±0.197	±0.118	±0.059		

ITEM CODE	20481513	20/03/2025	CREATE DATE
LEGACY CODE	12SWS0922B	PA66	MATERIAL
		BLACK	COLOUR
		-	FINISH

TITLE:
SHOULDER WASHER
 -

DWG. No.	20481513	SCALE	ISSUE
		5:1	1
		SHEET	2 of 2

